

360ml Clear Tumbler Biocup Q-360

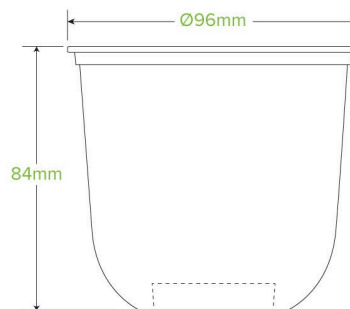

Carton quantity: 1000	Sleeves per carton: 20	Units per sleeve: 50
Carton Size LxWxH (cm): 49.0 x 40.0 x 48.0	Carton gross weight (kg): 10.200000	Carton barcode: 19344062035258
Raw material: Bioplastic - Ingeo™ PLA	Lining/coating: None	Window material: None
Printing Type: Offset	Inks: Food Contact Safe Inks	Brim fill capacity (ml): 392
Dimensions top LxW (mm): 96x96	Dimensions base LxW (mm): 48x48	Product Depth: 84.0
Product weight (g): 9.4	Use: Cold use only	Manufactured: Taiwan
Customise: Print	MOQ custom: 50000	Mould fees: Yes - see custom packaging
Environmental production certified: ISO 14001	Quality product certified: ISO 9001	Factory food safety certified: HACCP
Corporate social accreditation: SA 8000	Home compostable: No	Industrially compostable: Certified to AS4376 Australian Standards, Certified to EN13432 European Standard
Recyclable: No		