

200ml Clear BioCup R-200Y

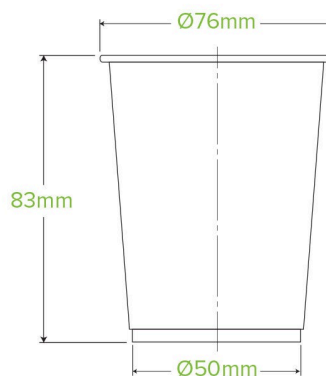

Carton quantity: 2000	Sleeves per carton: 20	Units per sleeve: 100
Carton Size LxWxH (cm): 61.0 x 40.0 x 33.0	Carton gross weight (kg): 9.700000	Carton barcode: 19344062000621
Raw material: Bioplastic - Ingeo™ PLA	Lining/coating: None	Window material: None
Printing Type: Offset	Inks: Food Contact Safe Inks	Brim fill capacity (ml): 228
Dimensions top LxW (mm): 76x76	Dimensions base LxW (mm): 50x50	Product Depth: 83.0
Product weight (g): 4.7	Use: Cold use only	Manufactured: Taiwan
Customise: Print	MOQ custom: 50000	Mould fees: Yes - see custom packaging
Environmental production certified: ISO 14001	Quality product certified: ISO 9001	Factory food safety certified: HACCP
Corporate social accreditation: SA 8000, SEDEX	Home compostable: No	Industrially compostable: Certified to AS4376 Australian Standards
Recyclable: No		